

2024年度 学総大会南部地区大会 女子ダブルス

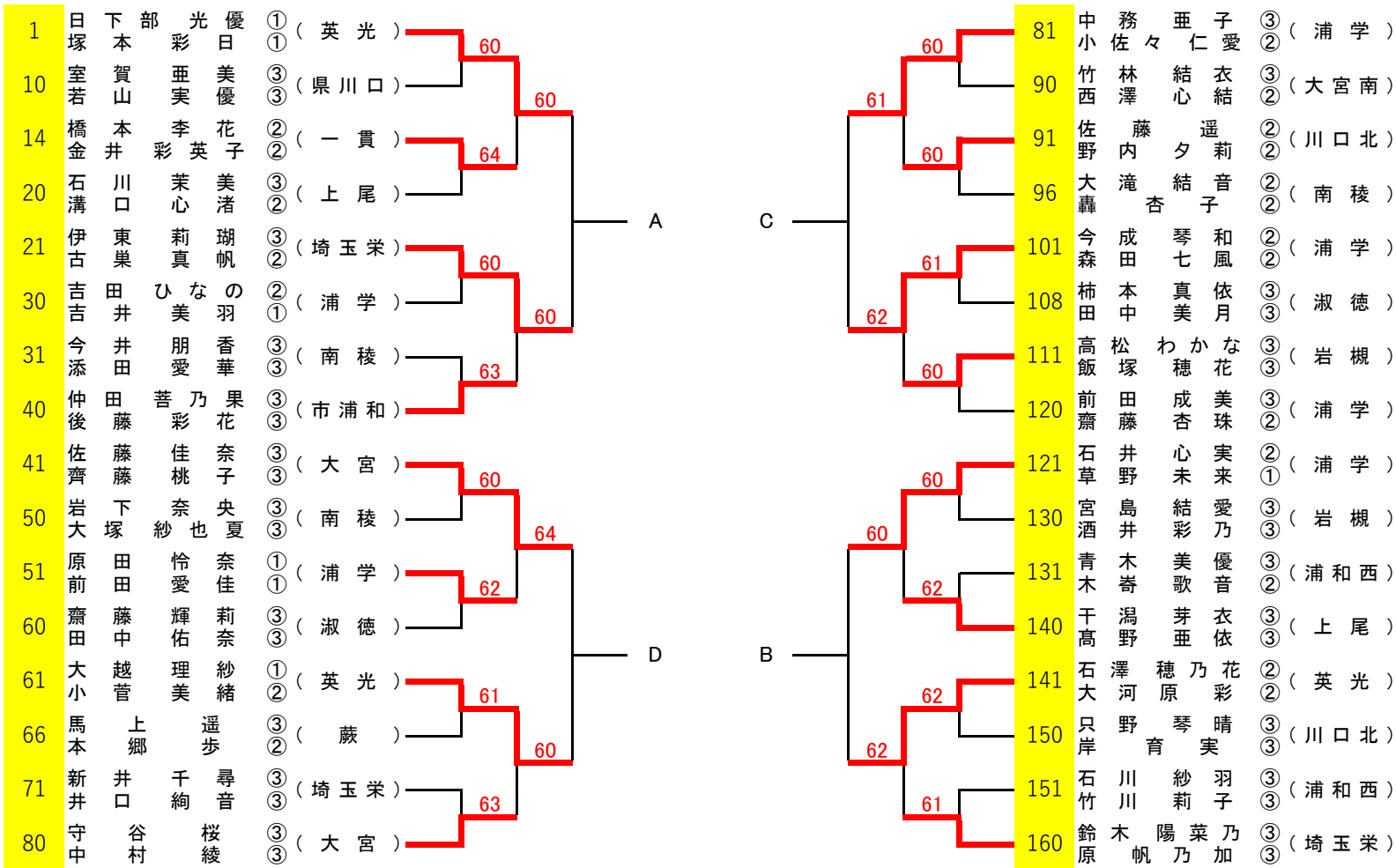

フィードイン戦

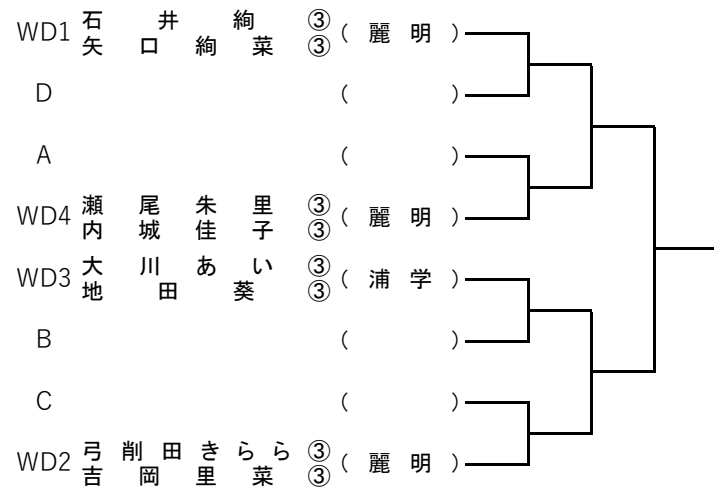

3位・4位

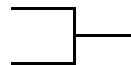
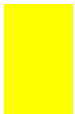

5~8位

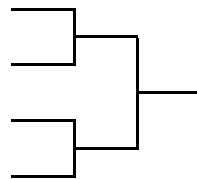
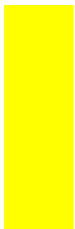

7・8位

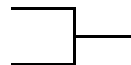
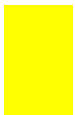

9~12位

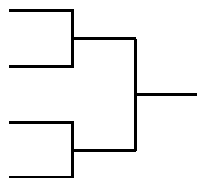

11・12位

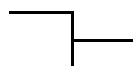

13~20位

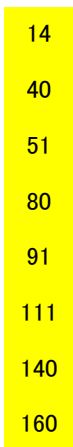

14	橋本	李	花子	② (一貫)
40	金井	彩英	乃果	③ (市浦和)
	仲田	菩乃	花奈	③ (浦学)
51	後藤	彩	佳	① (大宮)
	原田	怜愛		③ (川口北)
80	守中	谷村	桜綾	② (岩槻)
91	佐藤	藤	遥	③ (上尾)
	野内	夕	莉	③ (埼玉栄)
111	高松	わか	な	
140	飯塚	穂	花	
	干潟	芽	衣	
160	高野	亜	依	
	鈴木	陽	菜	
	原帆	乃	乃	
			加	

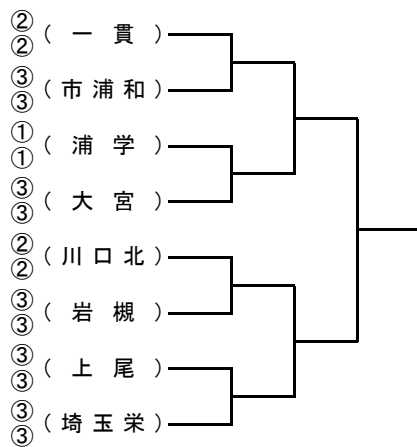

15・16位

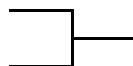

17~20位

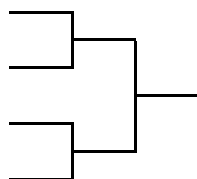

19・20位

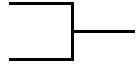
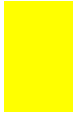

21~36位

10	室若石溝吉吉今添岩大齋田馬本新井竹西大轟柿田前齋宮酒青木只岸石竹	賀山川口田井田下塚藤中上郷井口林澤滝杏本中田藤島井木寄野川川	亜実美心の羽香華央夏莉奈遥歩尋音衣結音子依月美珠愛乃優音晴実羽子	③ (県川口)	61
20				③ (上尾)	
30				② (浦学)	61
31				③ (南稜)	
50				③ (南稜)	64
60				③ (淑徳)	
66				③ (蕨)	61
71				③ (埼玉栄)	
90				③ (大宮南)	64
96				② (南稜)	
108				② (淑徳)	64
120				③ (浦学)	
130				③ (岩槻)	62
131				③ (浦和西)	
150				③ (川口北)	76
151				③ (浦和西)	(4)

27・28位

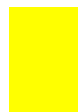

29~36位

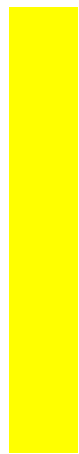

31・32位

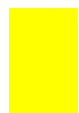

33~36位

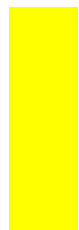

35・36位

