

2024年度 学校総合体育大会 南部地区予選会 女子シングルス

女子シングルス順位対戦表
1~24位(フィードイン)

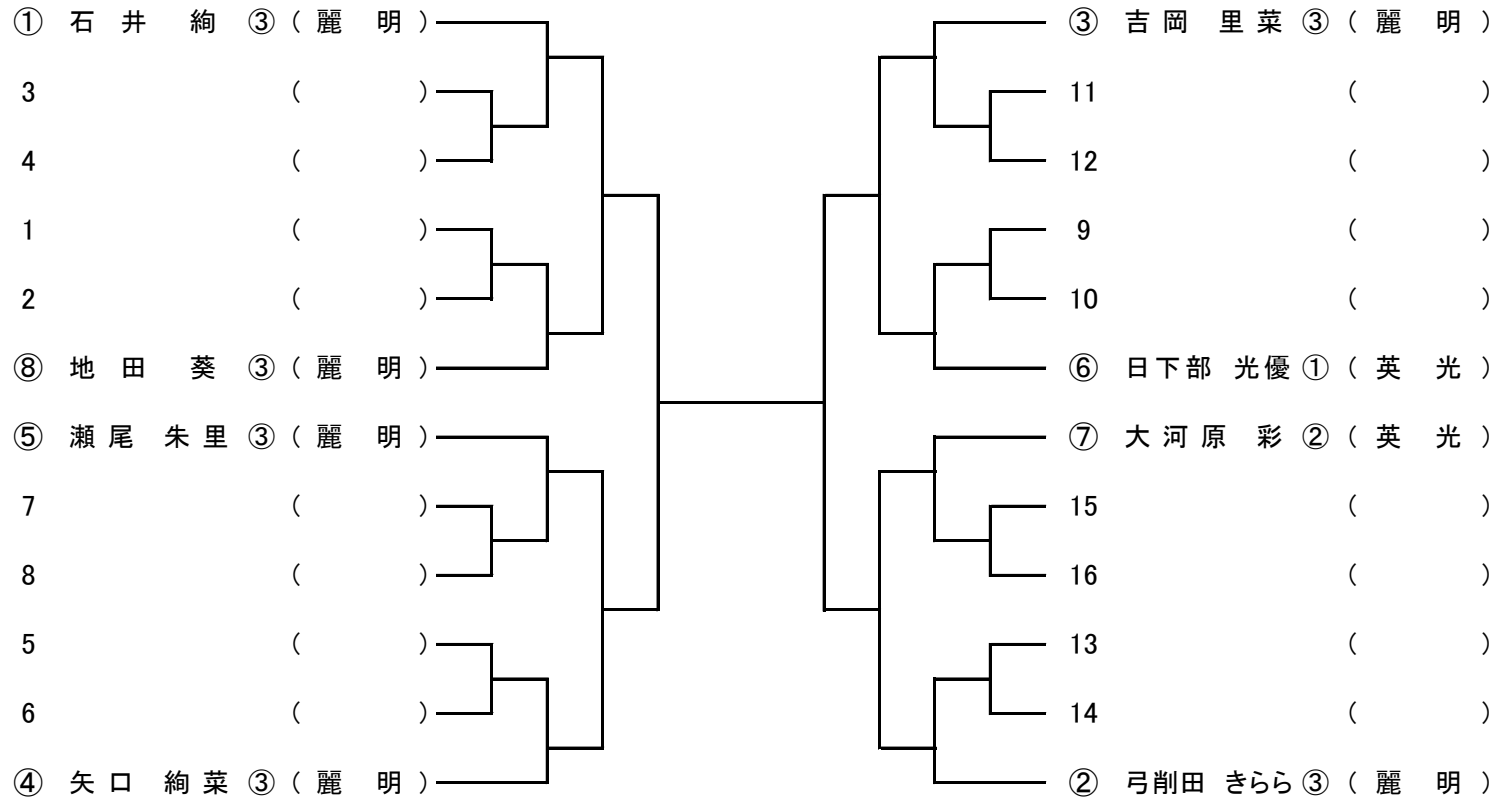

(ドロ-番号)
↓ 3・4位 準決勝敗者戦



(ドロ-番号)
↓ 5~8位 4R敗者戦

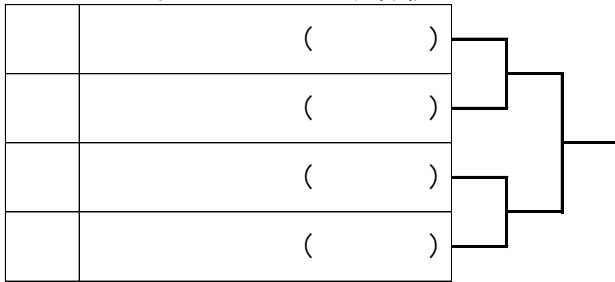

(ドロ-番号)
↓ 7・8位

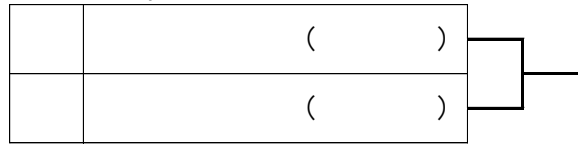

(ドロ-番号)
↓ 9~16位 3R敗者戦

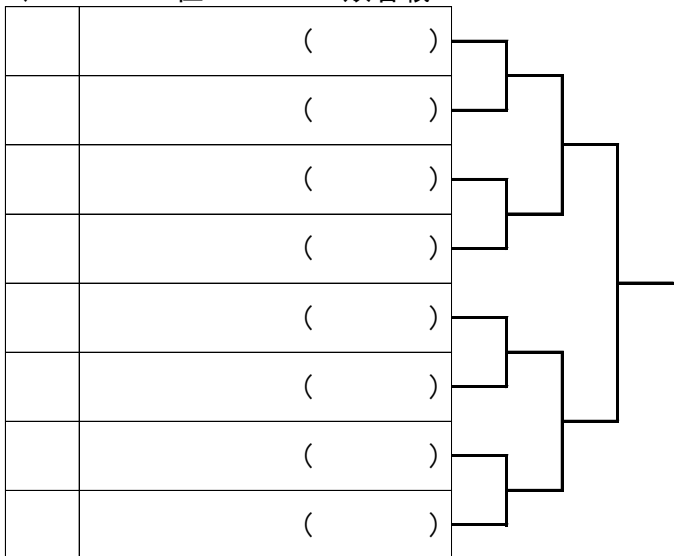

(ドロ-番号)
↓ 11・12位

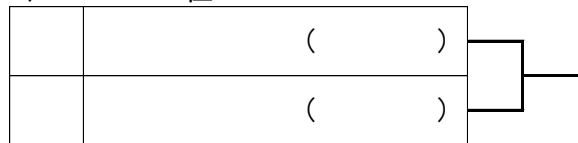

(ドロ-番号)
↓ 13~16位

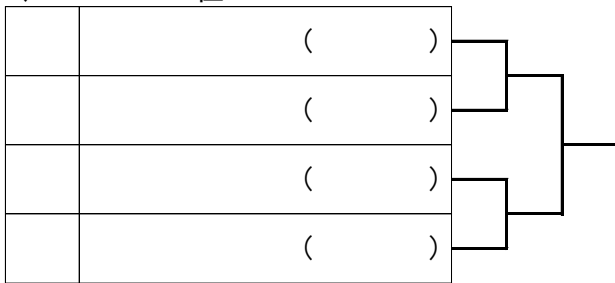

(ドロ-番号)
↓ 15・16位

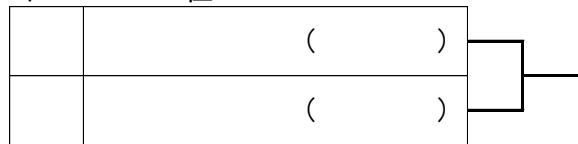

2024年度 学校総合体育大会 南部地区予選会 女子シングルス

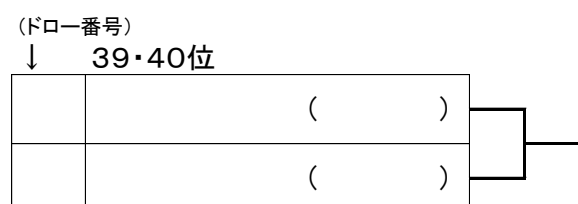
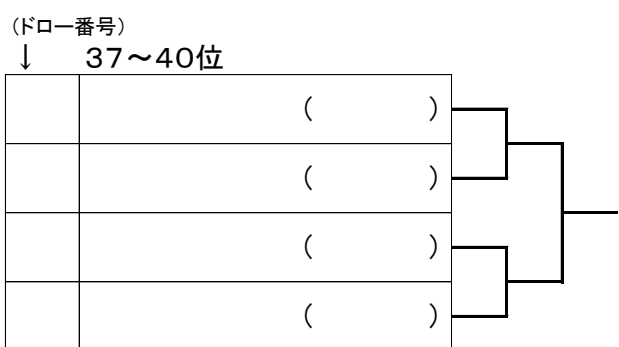
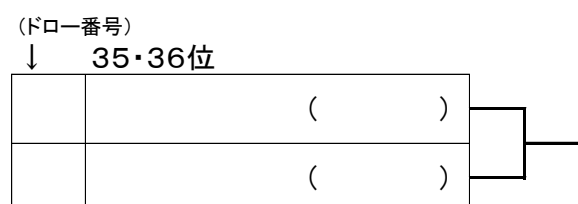
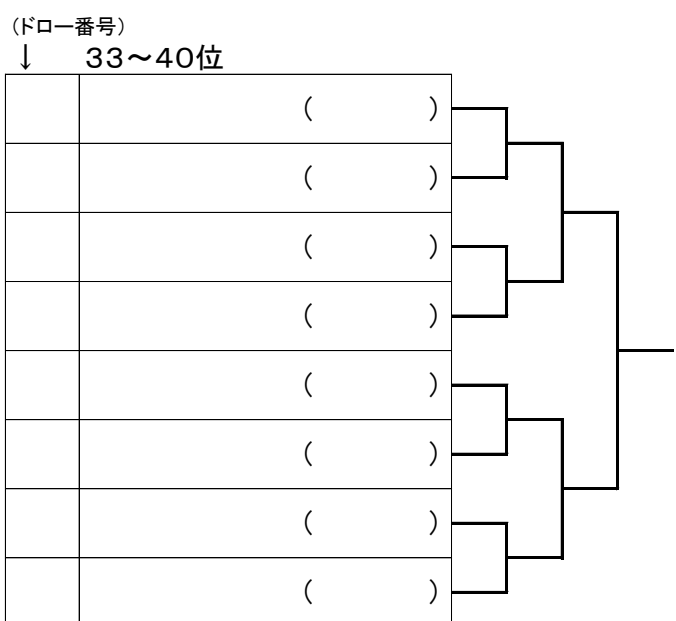
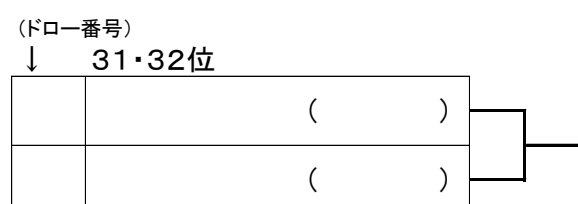
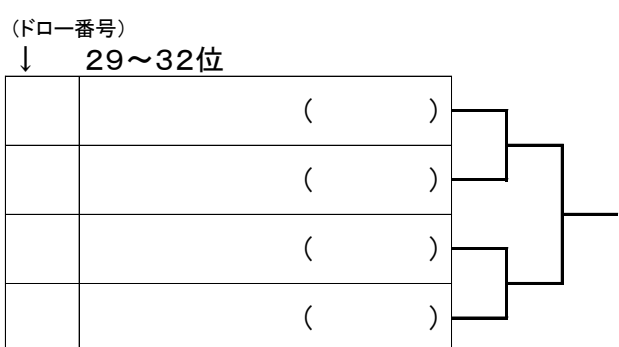
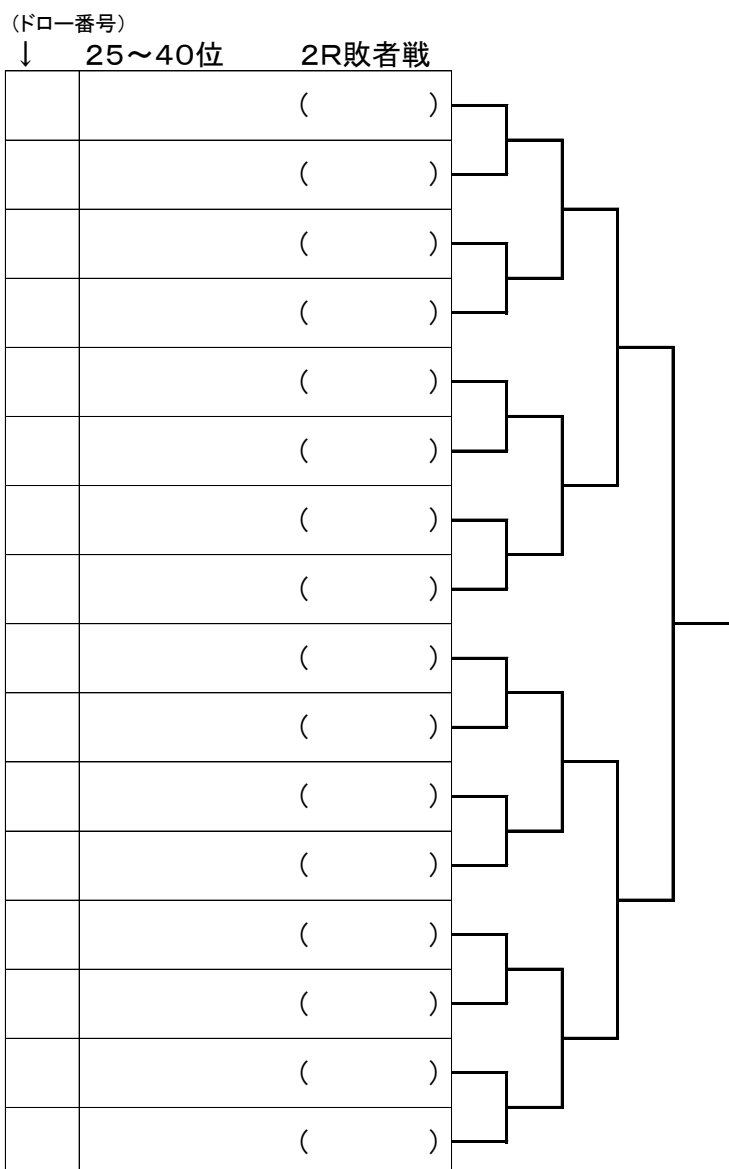
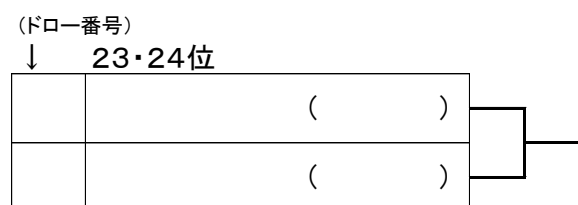
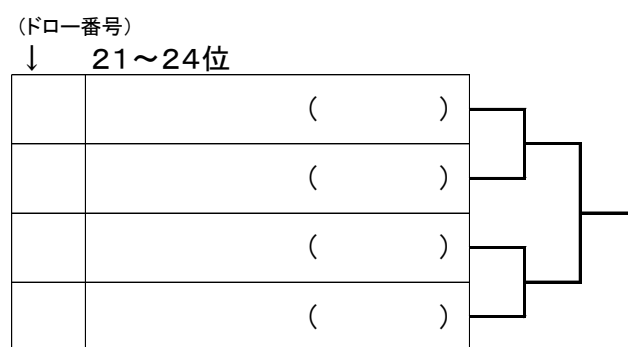
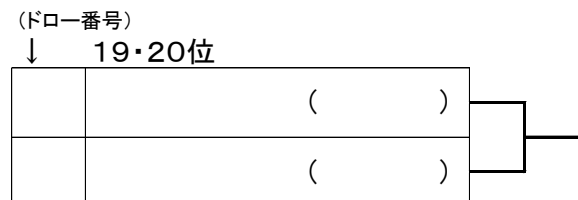
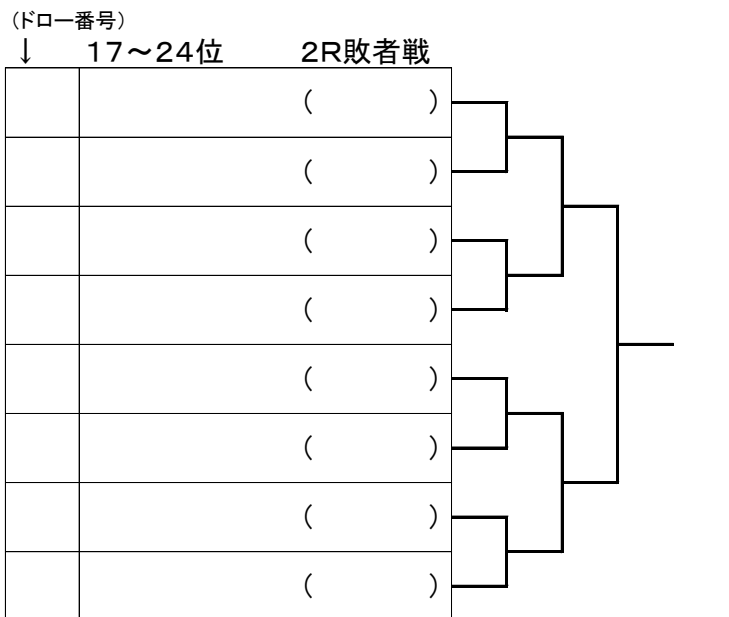

2024年度 学校総合体育大会 南部地区予選会 女子シングルス

