

2023年度 学総大会南部地区大会 男子シングルス

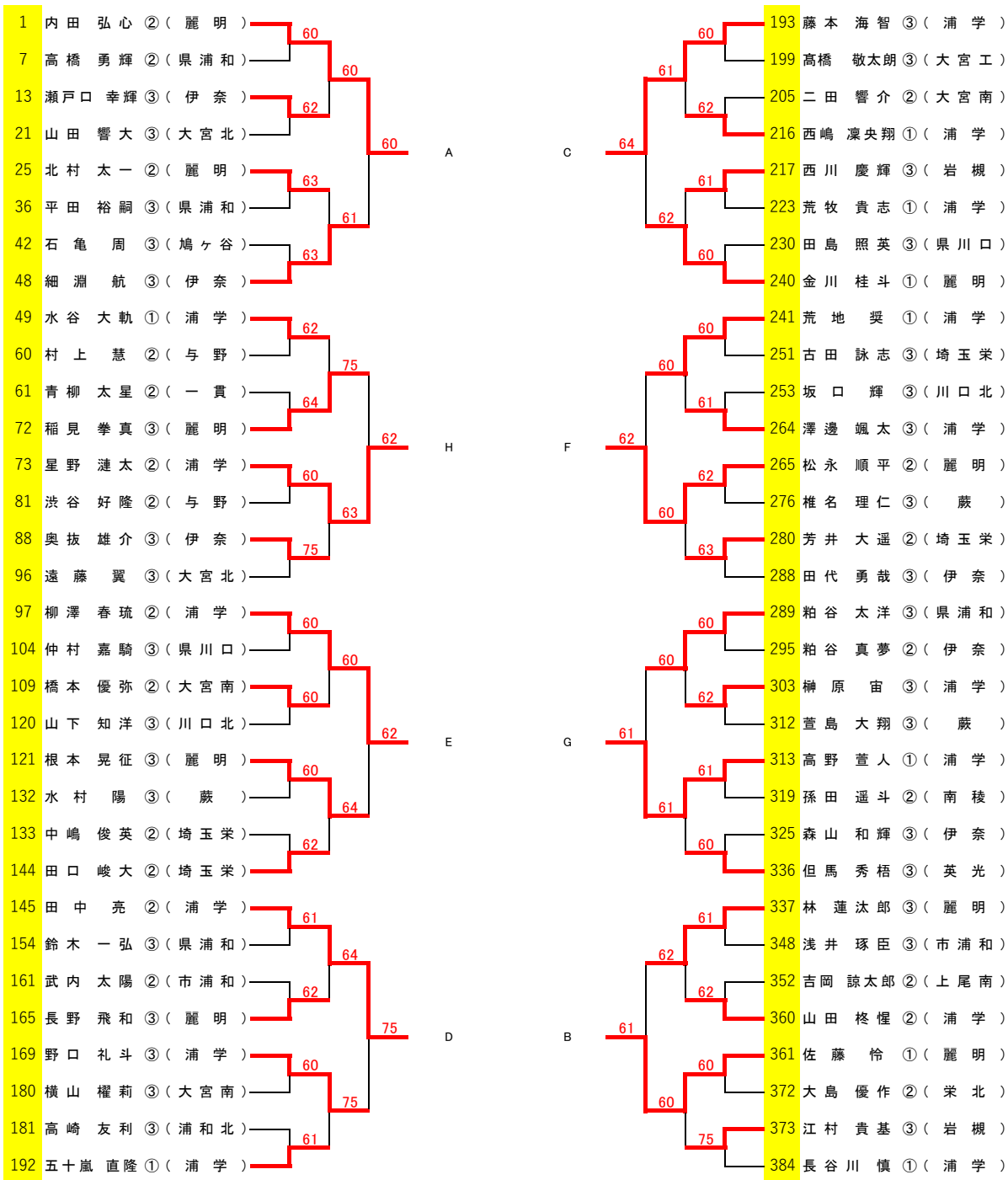

# フィードイン戦

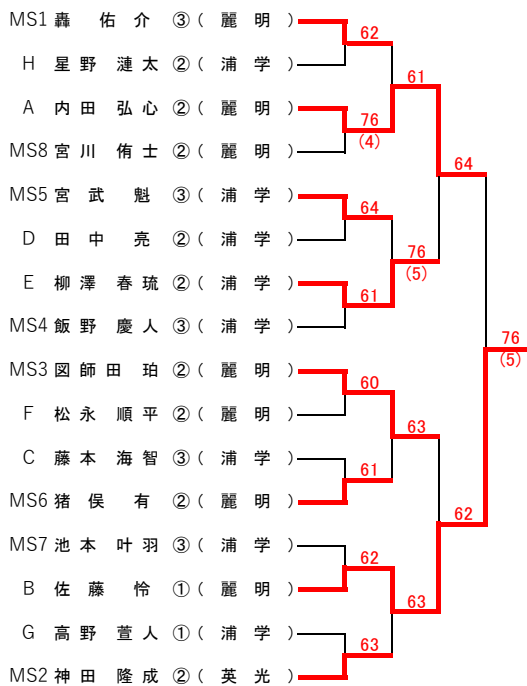

## 3・4位

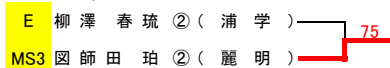

## 5~8位

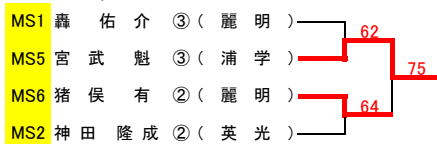

## 7・8位

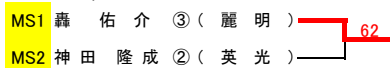

## 9~16位



## 11・12位

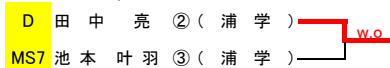

## 13~16位

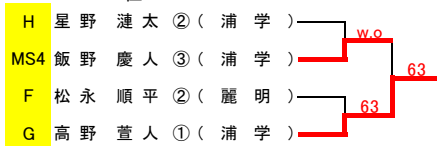

## 15・16位

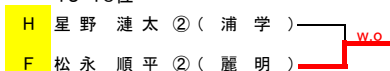

17~24位



19・20位

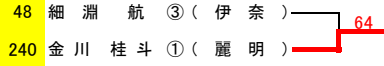

21~24位

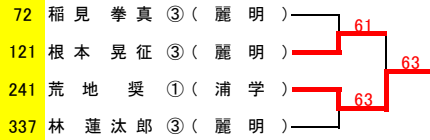

23・24位

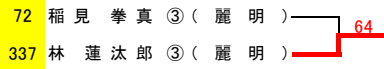

25~40位

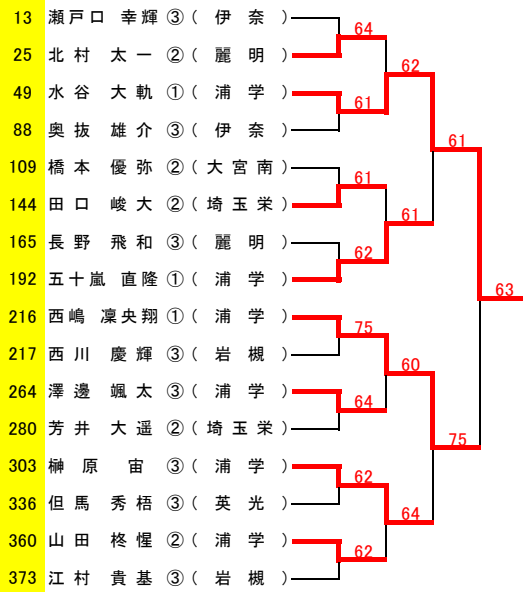

33~40位

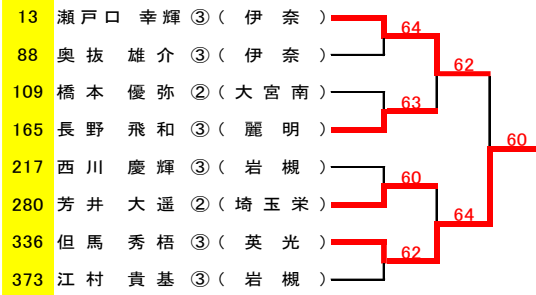

35・36位

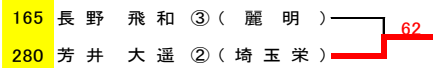

37~40位

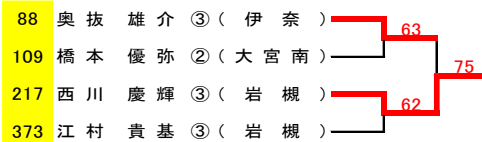

39・40位

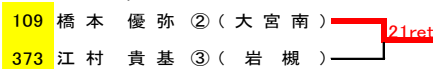

27・28位



29~32位

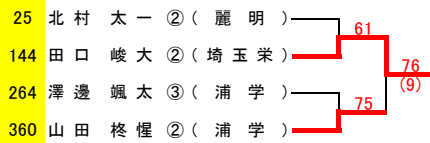

31・32位

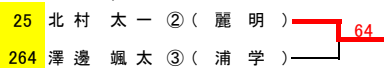

41~72位

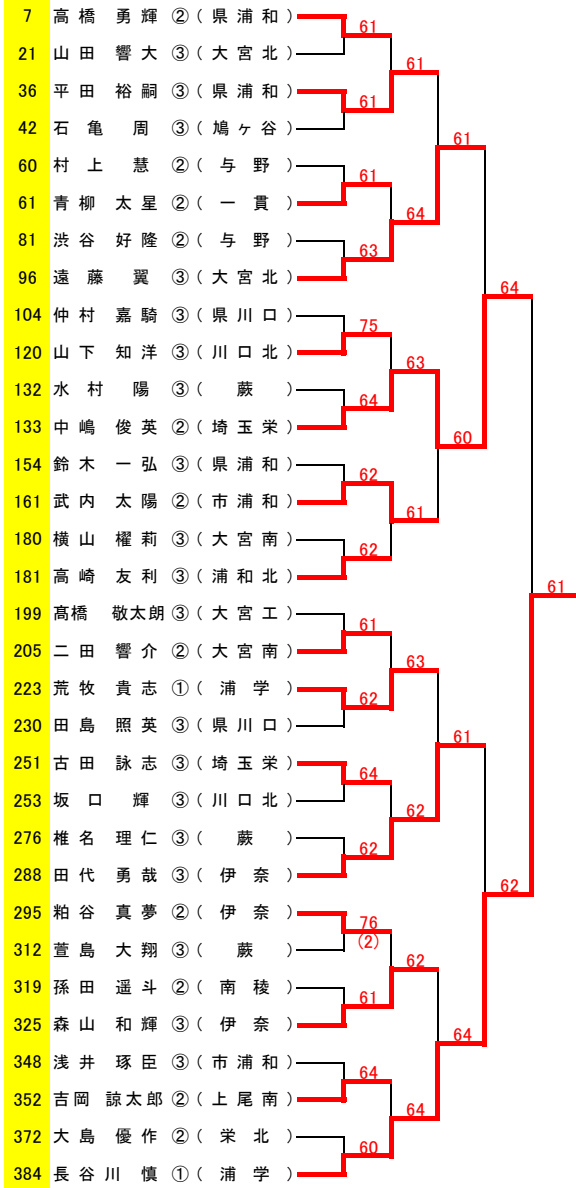

43・44位

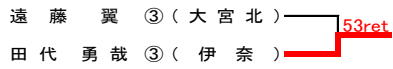

45~48位

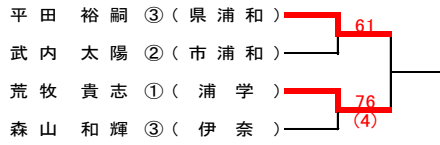

47・48位

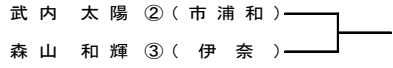

49~56位

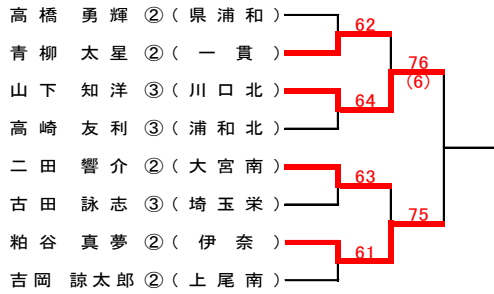

51・52位

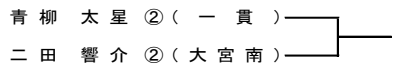

53~56位

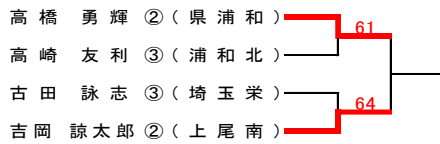

55・56位

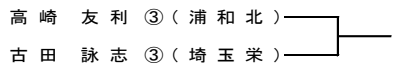

57~72位

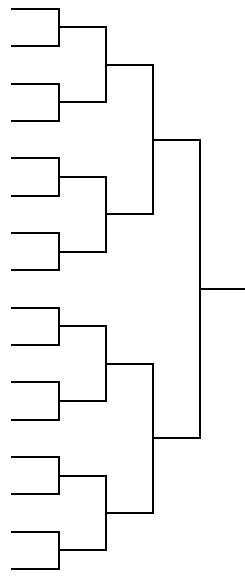

65~72位

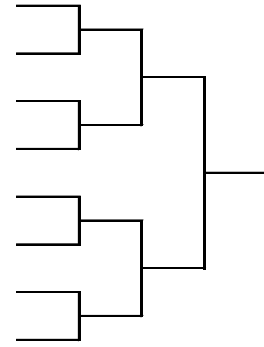

59~60位

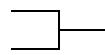

67·68位

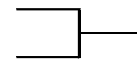

61~64位

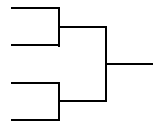
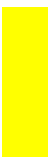

69~72位

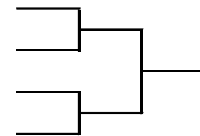

63·64位

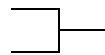

71·72位

